

TRIMO TRIMOTERM



TRIMO

TRIMO D.O.O.
PRIJATELJEVA CESTA 12
8210 TREBNJE | SLOVENIJA
T: +386 (0)7 34 60 200
F: +386 (0)7 34 60 127
E: TRIMO@TRIMO-GROUP.COM
W: WWW.TRIMO-GROUP.COM

Trimo Group holds full copyrights on the information and details provided on this media, therefore any unauthorized reproduction and distribution is strictly prohibited. Professional care has been taken to ensure that information/details are accurate, correct, complete and not misleading. However, Trimo (including its subsidiaries) does not accept responsibility or liability for errors or information which is found to be misleading. Information/details on this media are for general purposes only. Use of it is on your own initiative and responsibility for compliance with local laws is yours. Any deviations in details and project solutions are user responsibility. In no event, will Trimo be liable for any loss or damage including without limitation, indirect or consequential loss or damage, or any loss or damage whatsoever arising from loss profits arising out of or in connection with, the use of this media. All information issued by Trimo Group is subject to continuous development and information/details contained on this media are current at date of issue. It is user's responsibility to obtain most up-to-date information from Trimo when information/details are used for project.

The last version of the document is available on www.trimo-group.com. Latest version of published document in English language prevails over other translated language documents.

For information about the delivery of panels see Trimo's General conditions. <https://trimo-group.com/en/trimo/general-conditions-of-sale>

ARCHITECTURAL DETAILS FLAT ROOF SYSTEM TRIMOTERM FTV

FLAT INSTALLATION

TRIMOTERM FTV

FUNCTION

- FIRE - fire-resistant system
- FOOGIENE - food & hygiene system
- BASE - backing-wall system

APPLICATION

- External Facade
- Internal Wall
- Flat Roof
- External Soffit
- Internal Ceiling
- Pitched Roof



CAD download centre



BIM download centre

- TE-F-01 JOINT
- TE-F-02 FIXING
- TE-F-03 PARAPET
- TE-F-04 GABLE
- TE-F-06 WALLEY
- TE-F-07 ADDITION
- TE-F-08 PENETRATION

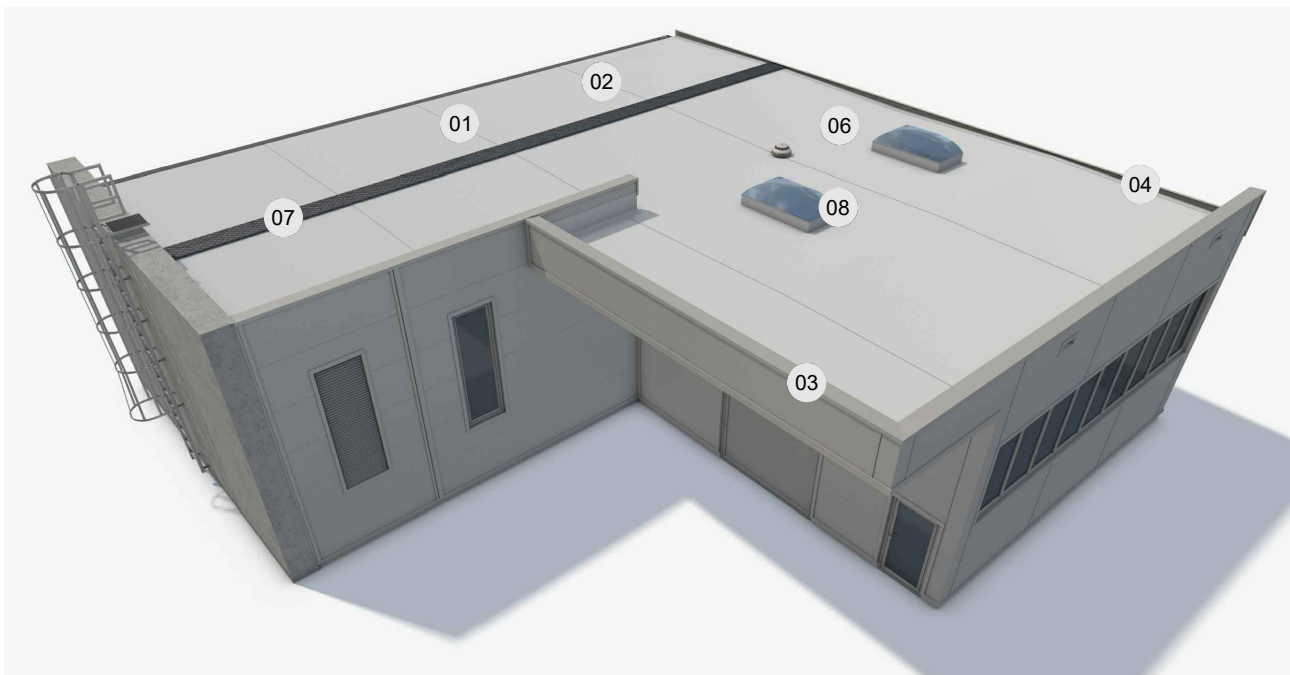

SCHEME



FLAT INSTALLATION

FUNCTION

- FIRE - fire-resistant system
- FOOGIENE - food & hygiene system
- BASE - backing-wall system

APPLICATION

- External Facade + External Soffit
- Internal Wall + Internal Ceiling
- Flat Roof Pitched Roof

TRIMOTERM FTV

VERTICAL CUT

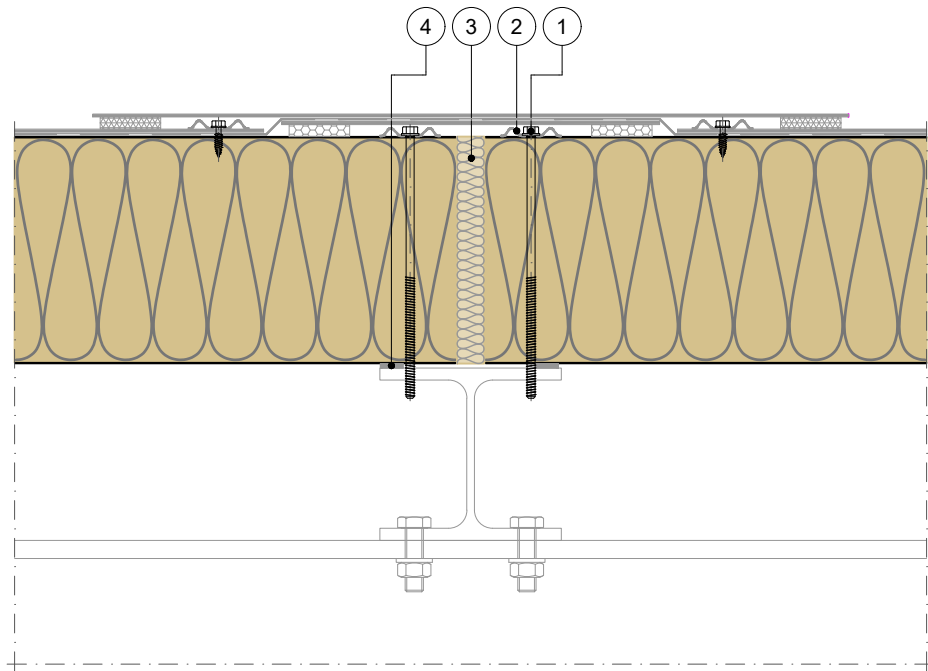

POS.	ELEMENT	SCALE: M 1:5
1	Fixing screw	
2	Stress plate	
3	Thermal insulation	
4	Sealing tape	

JOINT

Trimo Group holds full copyrights on the information and details provided on this media, therefore any unauthorized reproduction and distribution is strictly prohibited.



FLAT INSTALLATION

FUNCTION

- FIRE - fire-resistant system
- FOOGIENE - food & hygiene system
- BASE - backing-wall system

APPLICATION

- External Facade + External Soffit
- Internal Wall + Internal Ceiling
- Flat Roof Pitched Roof

TRIMOTERM FTV

DETAIL VIEW



CLOSE VIEW

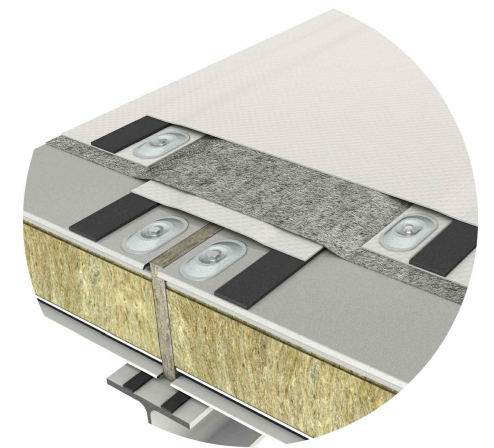

ADVANTAGES

- Prefabrication and load bearing
- Airtightness and internal side hygiene performance
- Compatibility and flexibility to other systems
- Sustainability and energy efficiency

JOINT

Trimo Group holds full copyrights on the information and details provided on this media, therefore any unauthorized reproduction and distribution is strictly prohibited.



FLAT INSTALLATION

TRIMOTERM FTV

FUNCTION

- FIRE - fire-resistant system
- FOOGIENE - food & hygiene system
- BASE - backing-wall system

APPLICATION

- External Facade
- Internal Wall
- Flat Roof
- External Soffit
- Internal Ceiling
- Pitched Roof

VERTICAL CUT

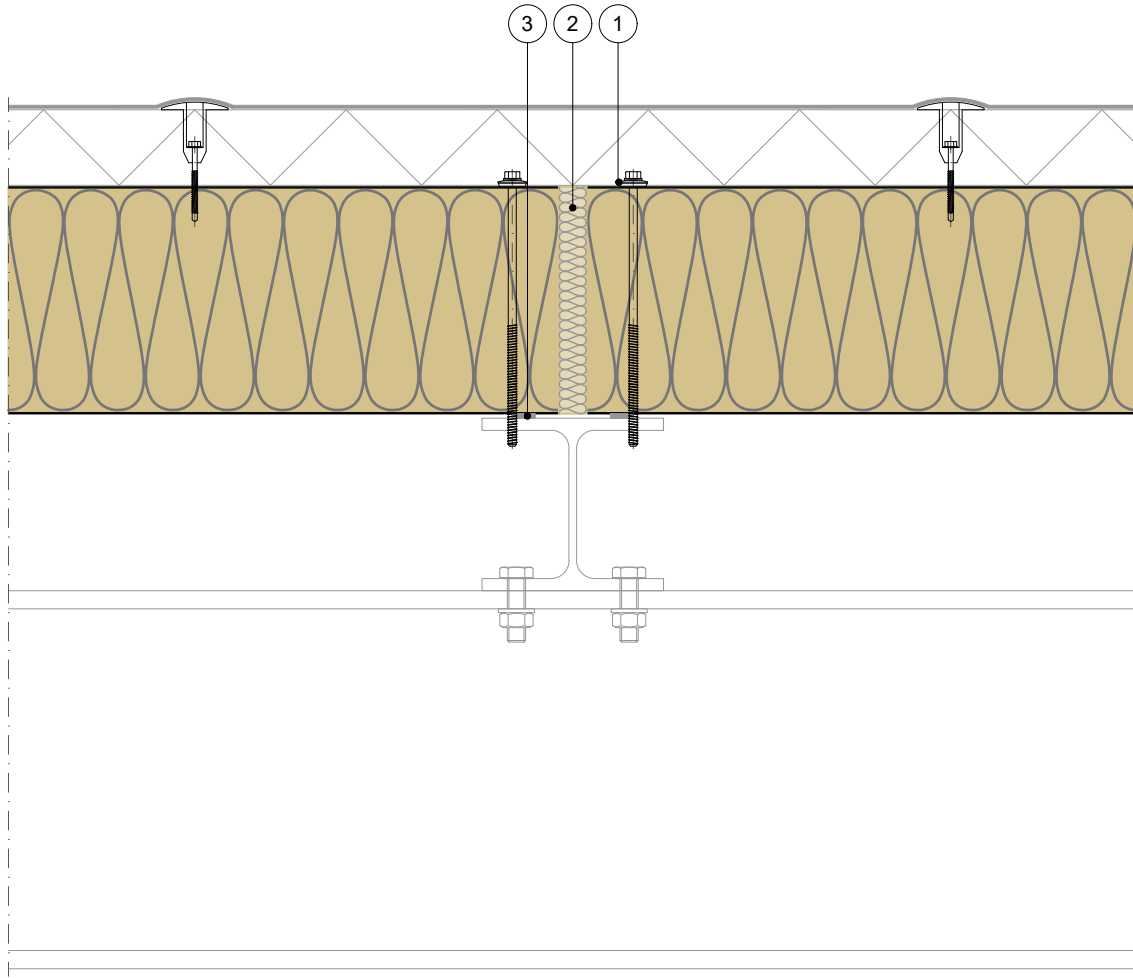

POS.	ELEMENT	SCALE: M 1:5
1	Fixing screw	
2	Thermal insulation	
3	Sealing tape	

JOINT

Trimo Group holds full copyrights on the information and details provided on this media, therefore any unauthorized reproduction and distribution is strictly prohibited.



FLAT INSTALLATION

TRIMOTERM FTV

FUNCTION

- FIRE - fire-resistant system
- FOOGIENE - food & hygiene system
- BASE - backing-wall system

APPLICATION

- External Facade + External Soffit
- Internal Wall + Internal Ceiling
- Flat Roof
- Pitched Roof

VERTICAL CUT

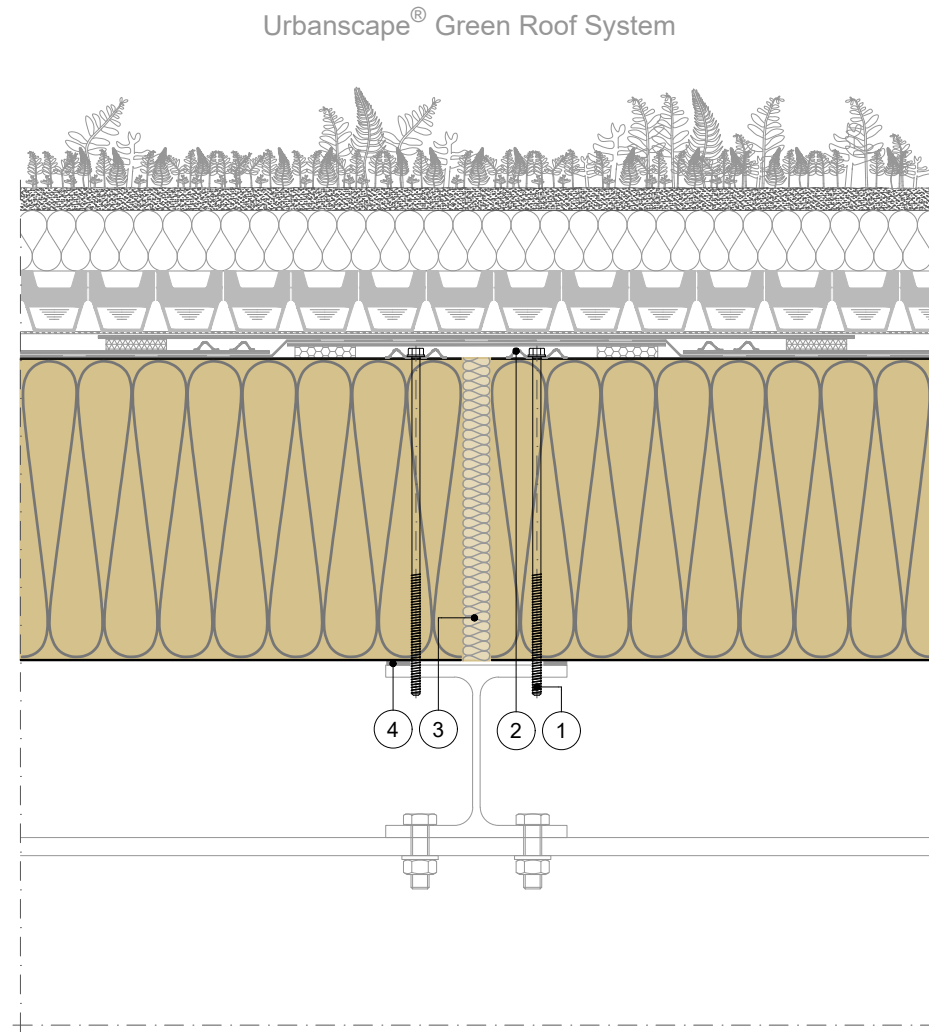

POS.	ELEMENT	SCALE: M 1:5
1	Fixing screw	
2	Stress plate	
3	Thermal insulation	
4	Sealing tape	

JOINT

Trimo Group holds full copyrights on the information and details provided on this media, therefore any unauthorized reproduction and distribution is strictly prohibited.



FLAT INSTALLATION

TRIMOTERM FTV

FUNCTION

- FIRE - fire-resistant system
- FOOGIENE - food & hygiene system
- BASE - backing-wall system

APPLICATION

- External Facade + External Soffit
- Internal Wall + Internal Ceiling
- Flat Roof
- Pitched Roof

DETAIL VIEW

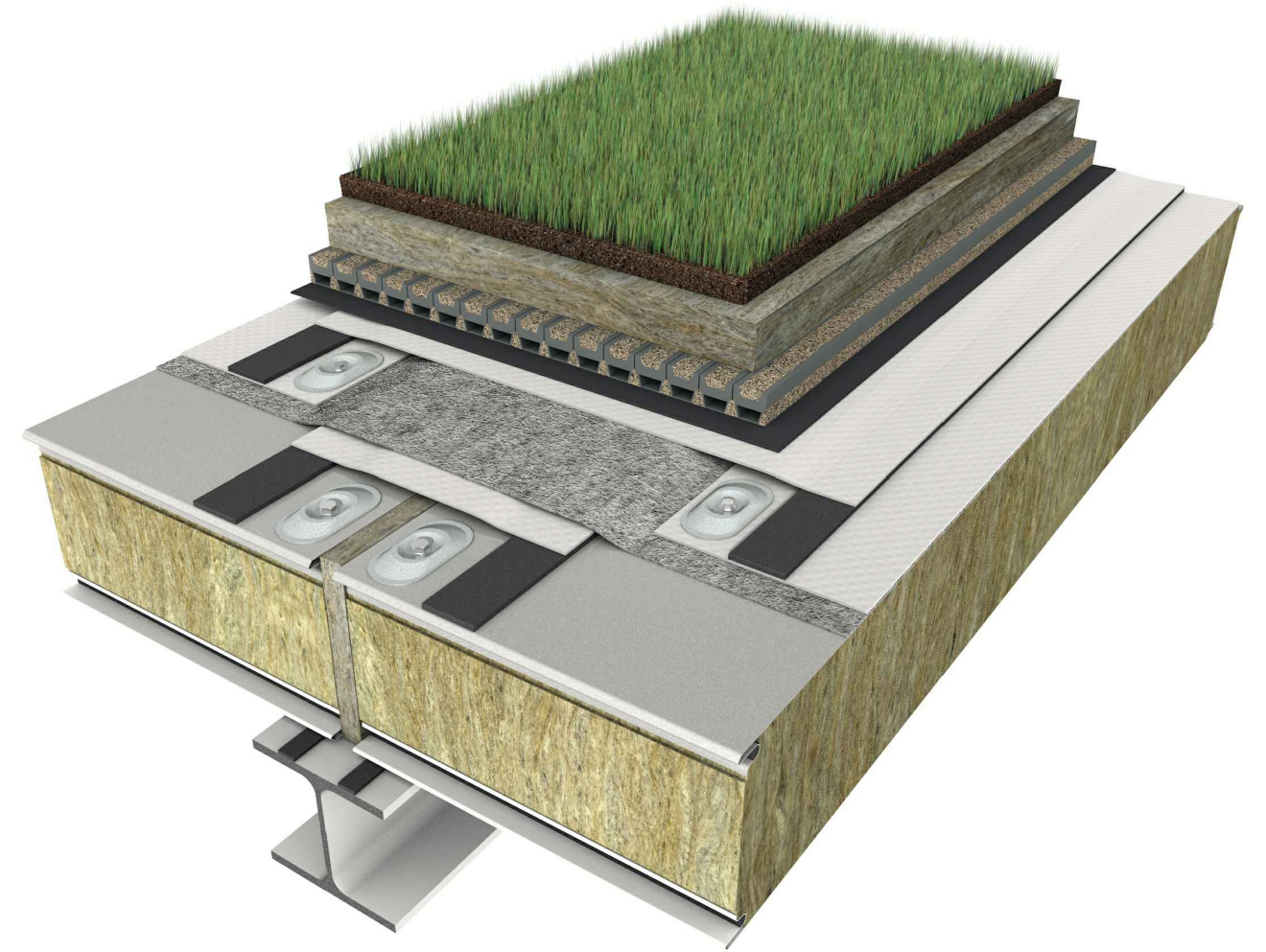

CLOSE VIEW

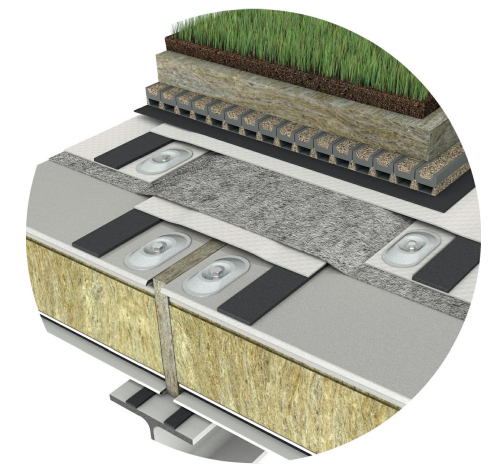

ADVANTAGES

- Prefabrication and load bearing
- Airtightness and internal side hygiene performance
- Compatibility and flexibility to other systems
- Sustainability and energy efficiency

JOINT

Trimo Group holds full copyrights on the information and details provided on this media, therefore any unauthorized reproduction and distribution is strictly prohibited.



FLAT INSTALLATION

FUNCTION

- FIRE - fire-resistant system
- FOOGIENE - food & hygiene system
- BASE - backing-wall system

APPLICATION

- External Facade + External Soffit
- Internal Wall + Internal Ceiling
- Flat Roof Pitched Roof

TRIMOTERM FTV

VERTICAL CUT

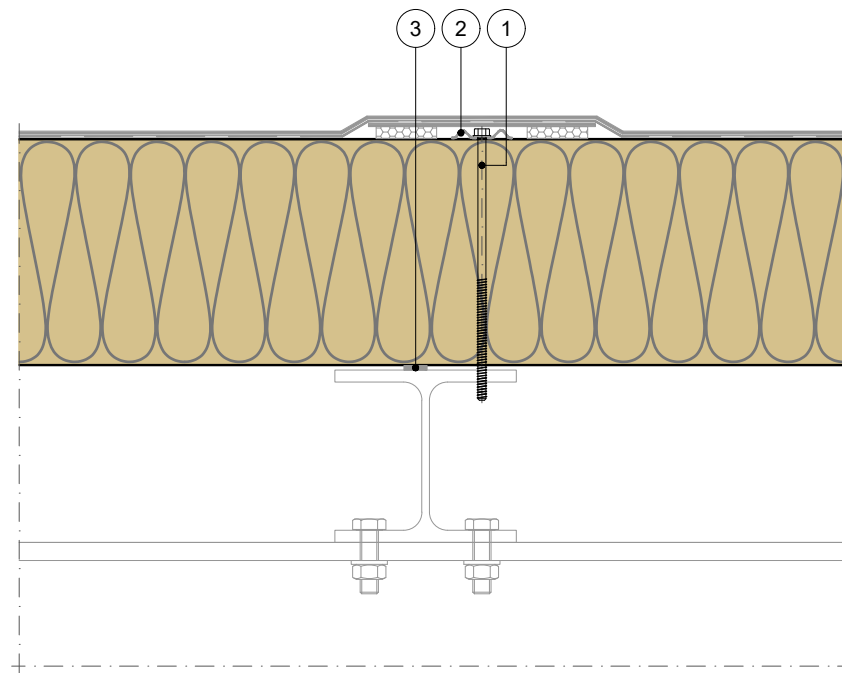

POS.	ELEMENT	SCALE: M 1:5
1	Fixing screw	
2	Stress plate	
3	Sealing tape	

FIXING

Trimo Group holds full copyrights on the information and details provided on this media, therefore any unauthorized reproduction and distribution is strictly prohibited.



FLAT INSTALLATION

FUNCTION

- FIRE - fire-resistant system
- FOOGIENE - food & hygiene system
- BASE - backing-wall system

APPLICATION

- External Facade + External Soffit
- Internal Wall + Internal Ceiling
- Flat Roof Pitched Roof

TRIMOTERM FTV

DETAIL VIEW



CLOSE VIEW

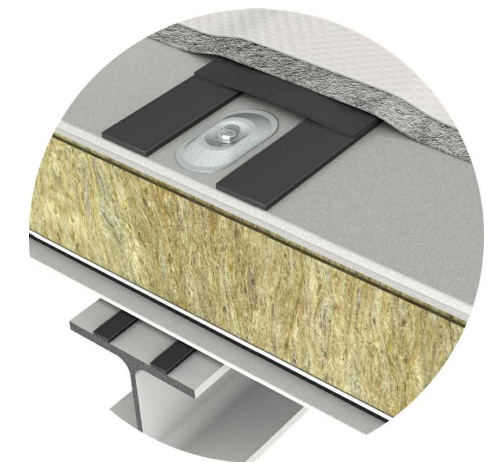

ADVANTAGES

- Prefabrication and load bearing
- Airtightness and internal side hygiene performance
- Compatibility and flexibility to other systems
- Sustainability and energy efficiency

FIXING

Trimo Group holds full copyrights on the information and details provided on this media, therefore any unauthorized reproduction and distribution is strictly prohibited.



FLAT INSTALLATION

TRIMOTERM FTV

FUNCTION

- FIRE - fire-resistant system
- FOOGIENE - food & hygiene system
- BASE - backing-wall system

APPLICATION

- External Facade + External Soffit
- Internal Wall + Internal Ceiling
- Flat Roof
- Pitched Roof

VERTICAL CUT

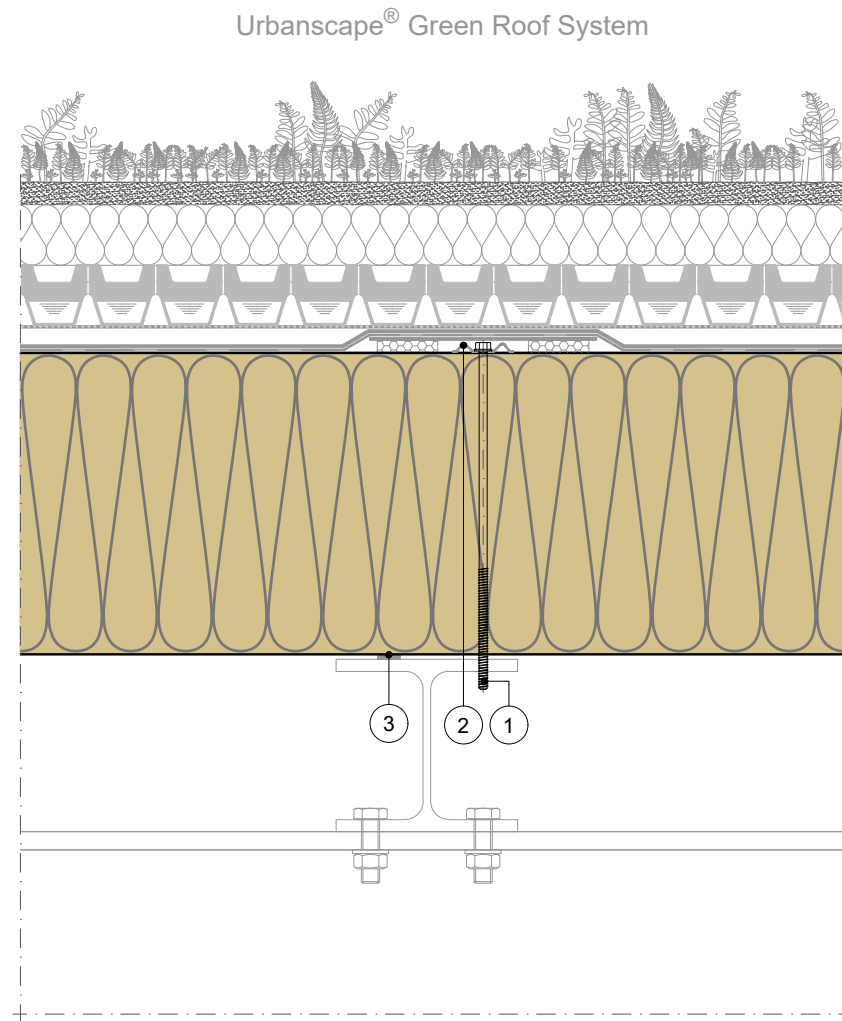

POS.	ELEMENT	SCALE: M 1:5
1	Fixing screw	
2	Stress plate	
3	Sealing tape	

FIXING

Trimo Group holds full copyrights on the information and details provided on this media, therefore any unauthorized reproduction and distribution is strictly prohibited.



FLAT INSTALLATION

TRIMOTERM FTV

FUNCTION

- FIRE - fire-resistant system
- FOOGIENE - food & hygiene system
- BASE - backing-wall system

APPLICATION

- External Facade + External Soffit
- Internal Wall + Internal Ceiling
- Flat Roof
- Pitched Roof

DETAIL VIEW

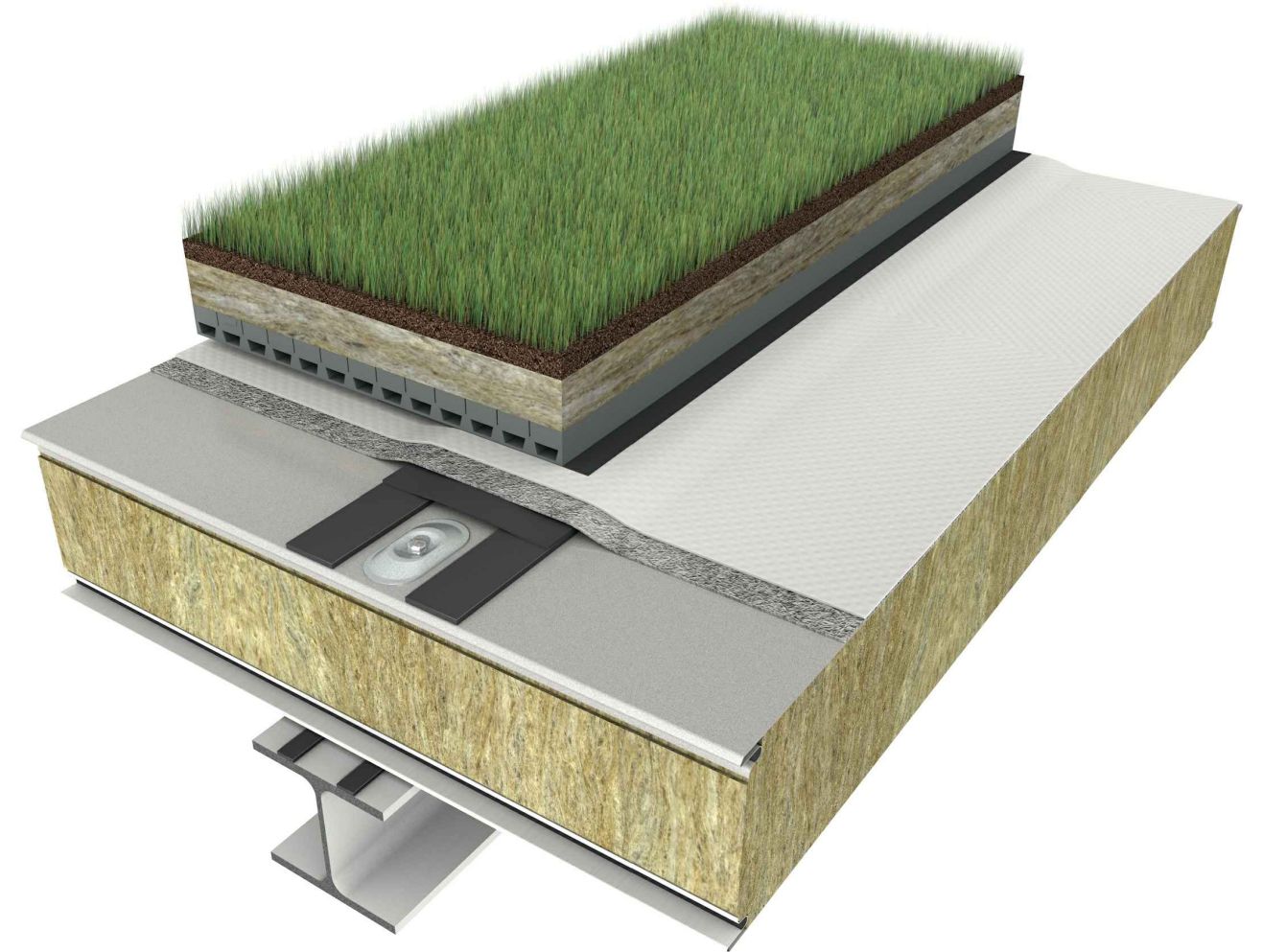

CLOSE VIEW

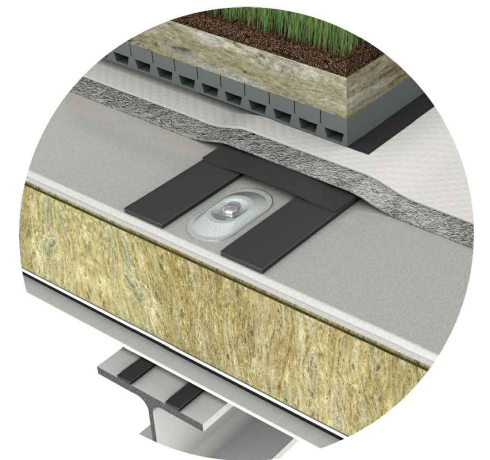

ADVANTAGES

- Prefabrication and load bearing
- Airtightness and internal side hygiene performance
- Compatibility and flexibility to other systems
- Sustainability and energy efficiency

FIXING

Trimo Group holds full copyrights on the information and details provided on this media, therefore any unauthorized reproduction and distribution is strictly prohibited.



FLAT INSTALLATION

FUNCTION

- FIRE - fire-resistant system
- FOOGIENE - food & hygiene system
- BASE - backing-wall system

APPLICATION

- External Facade + External Soffit
- Internal Wall + Internal Ceiling
- Flat Roof Pitched Roof

TRIMOTERM FTV

VERTICAL CUT

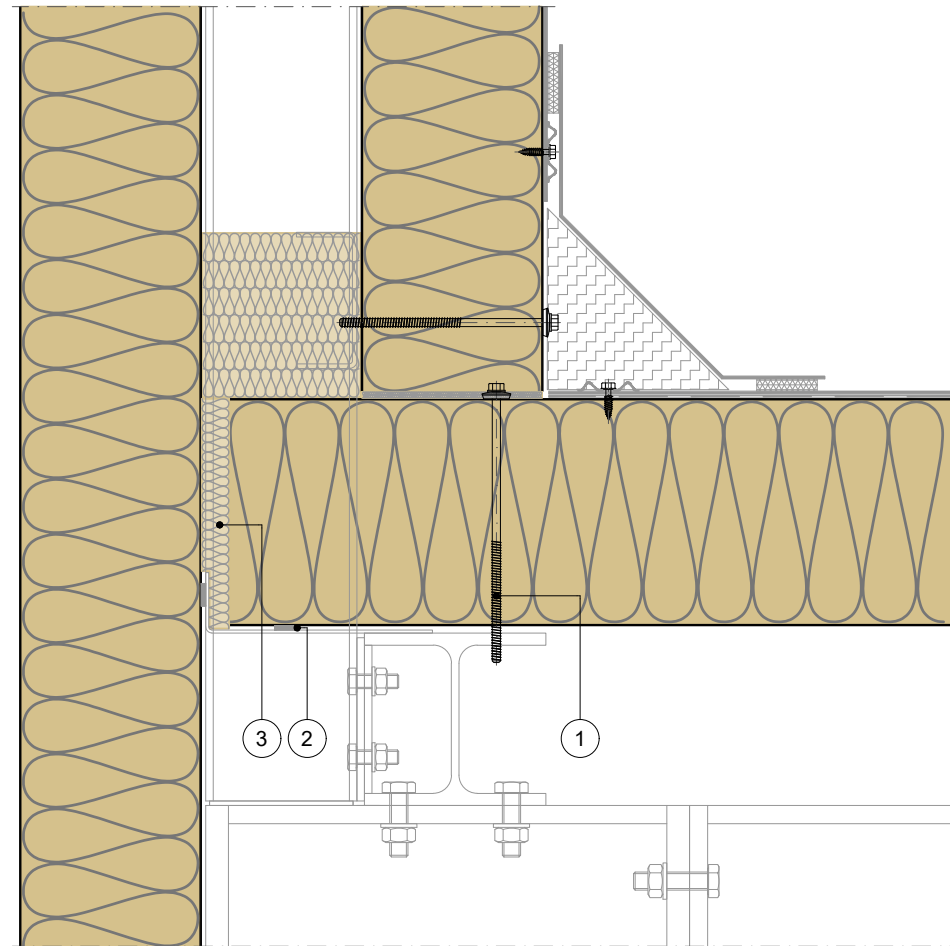

POS.	ELEMENT	SCALE: M 1:5
1	Fixing screw	
2	Sealing tape	
3	Thermal insulation	



FLAT INSTALLATION

FUNCTION

- FIRE - fire-resistant system
- FOOGIENE - food & hygiene system
- BASE - backing-wall system

APPLICATION

- External Facade + External Soffit
- Internal Wall + Internal Ceiling
- Flat Roof Pitched Roof

TRIMOTERM FTV

DETAIL VIEW

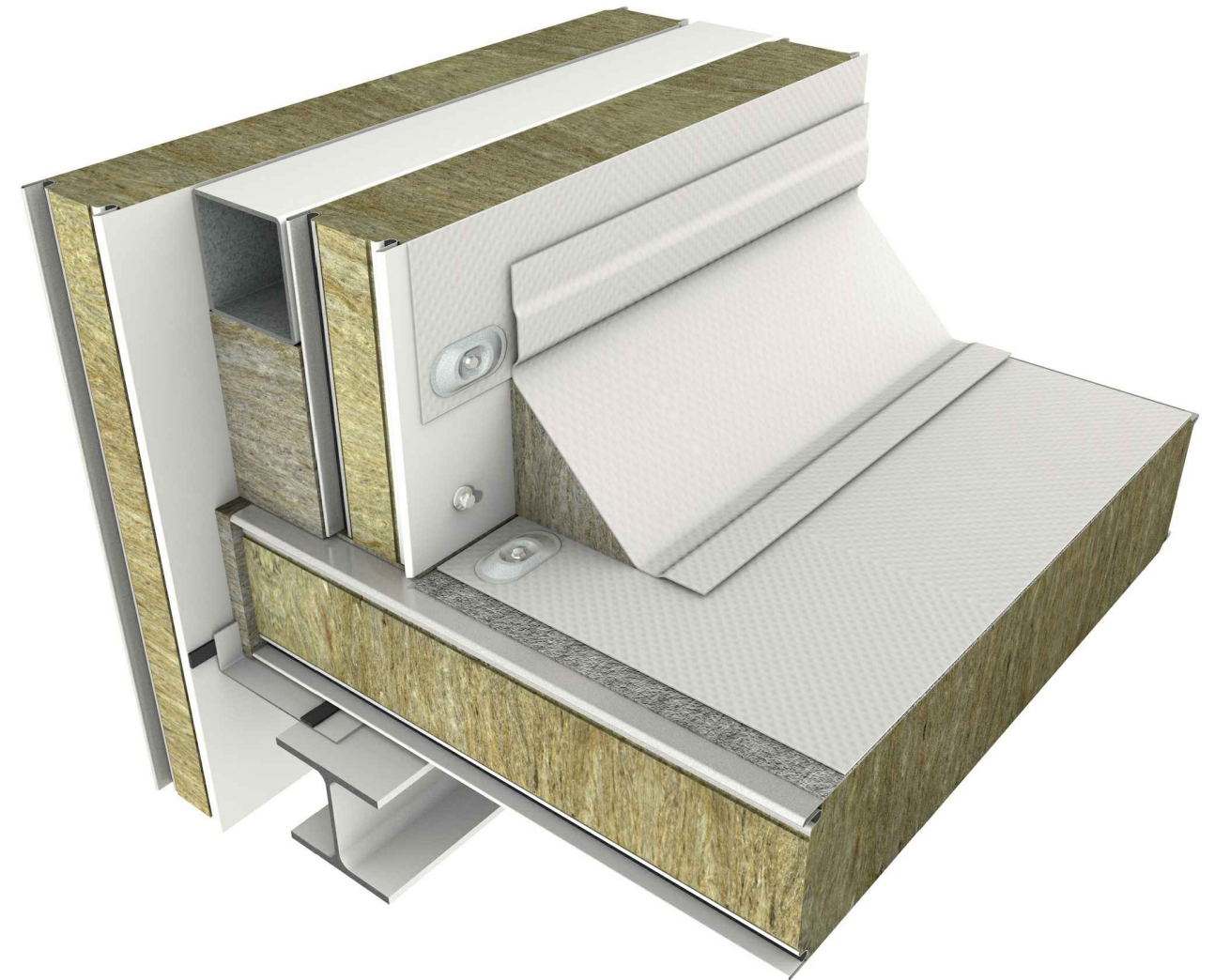

CLOSE VIEW

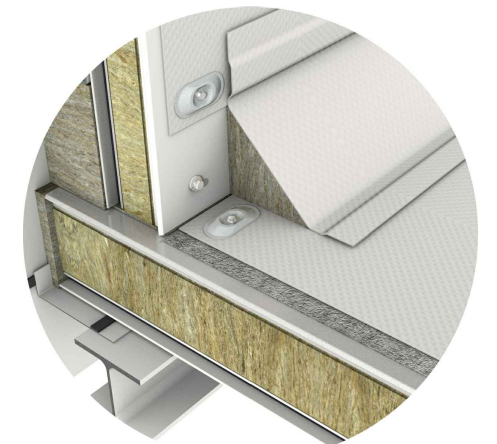

ADVANTAGES

- Prefabrication and load bearing
- Airtightness and internal side hygiene performance
- Compatibility and flexibility to other systems
- Sustainability and energy efficiency



FLAT INSTALLATION

TRIMOTERM FTV

FUNCTION

- FIRE - fire-resistant system
- FOOGIENE - food & hygiene system
- BASE - backing-wall system

APPLICATION

- External Facade
- Internal Wall
- Flat Roof
- External Soffit
- Internal Ceiling
- Pitched Roof

VERTICAL CUT

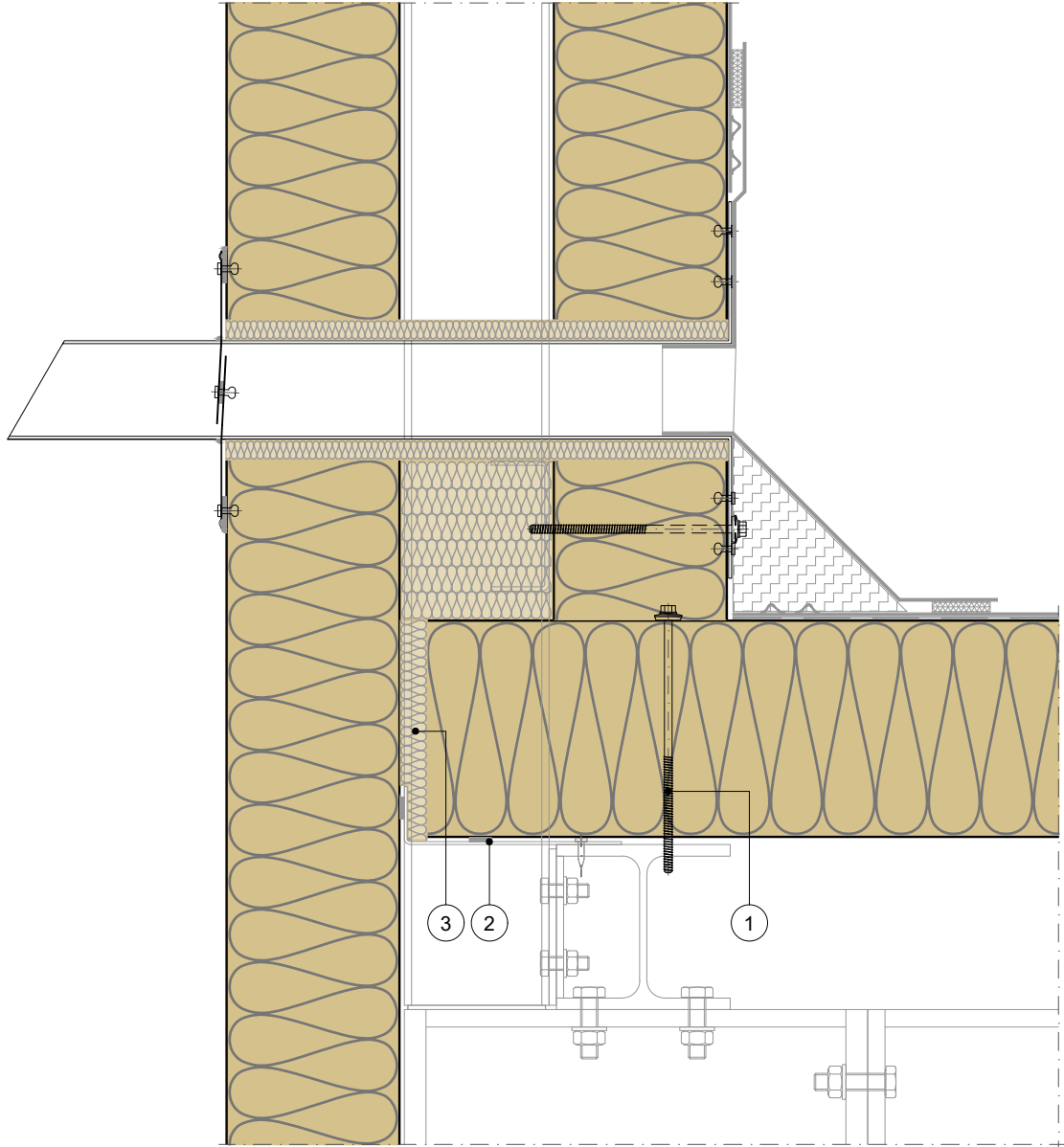

POS.	ELEMENT	SCALE: M 1:5
1	Fixing screw	
2	Sealing tape	
3	Thermal insulation	

PARAPET

Trimo Group holds full copyrights on the information and details provided on this media, therefore any unauthorized reproduction and distribution is strictly prohibited.



FLAT INSTALLATION

TRIMOTERM FTV

FUNCTION

- FIRE - fire-resistant system
- FOOGIENE - food & hygiene system
- BASE - backing-wall system

APPLICATION

- External Facade
- Internal Wall
- Flat Roof
- External Soffit
- Internal Ceiling
- Pitched Roof

VERTICAL CUT

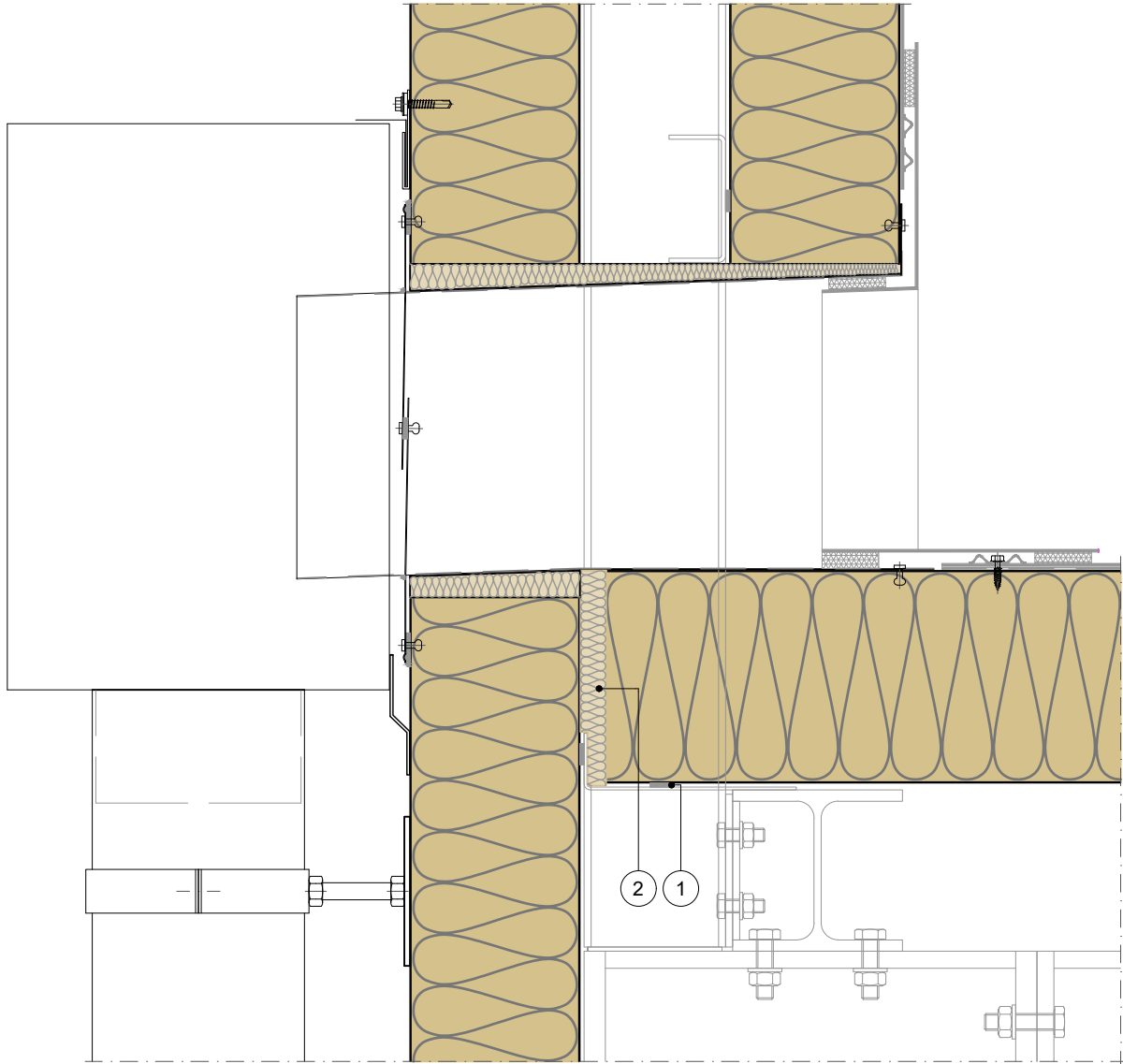

POS.	ELEMENT	SCALE: M 1:5
1	Sealing tape	
2	Thermal insulation	

PARAPET

Trimo Group holds full copyrights on the information and details provided on this media, therefore any unauthorized reproduction and distribution is strictly prohibited.



FLAT INSTALLATION

FUNCTION

- FIRE - fire-resistant system
- FOOGIENE - food & hygiene system
- BASE - backing-wall system

APPLICATION

- External Facade + External Soffit
- Internal Wall + Internal Ceiling
- Flat Roof Pitched Roof

TRIMOTERM FTV

VERTICAL CUT

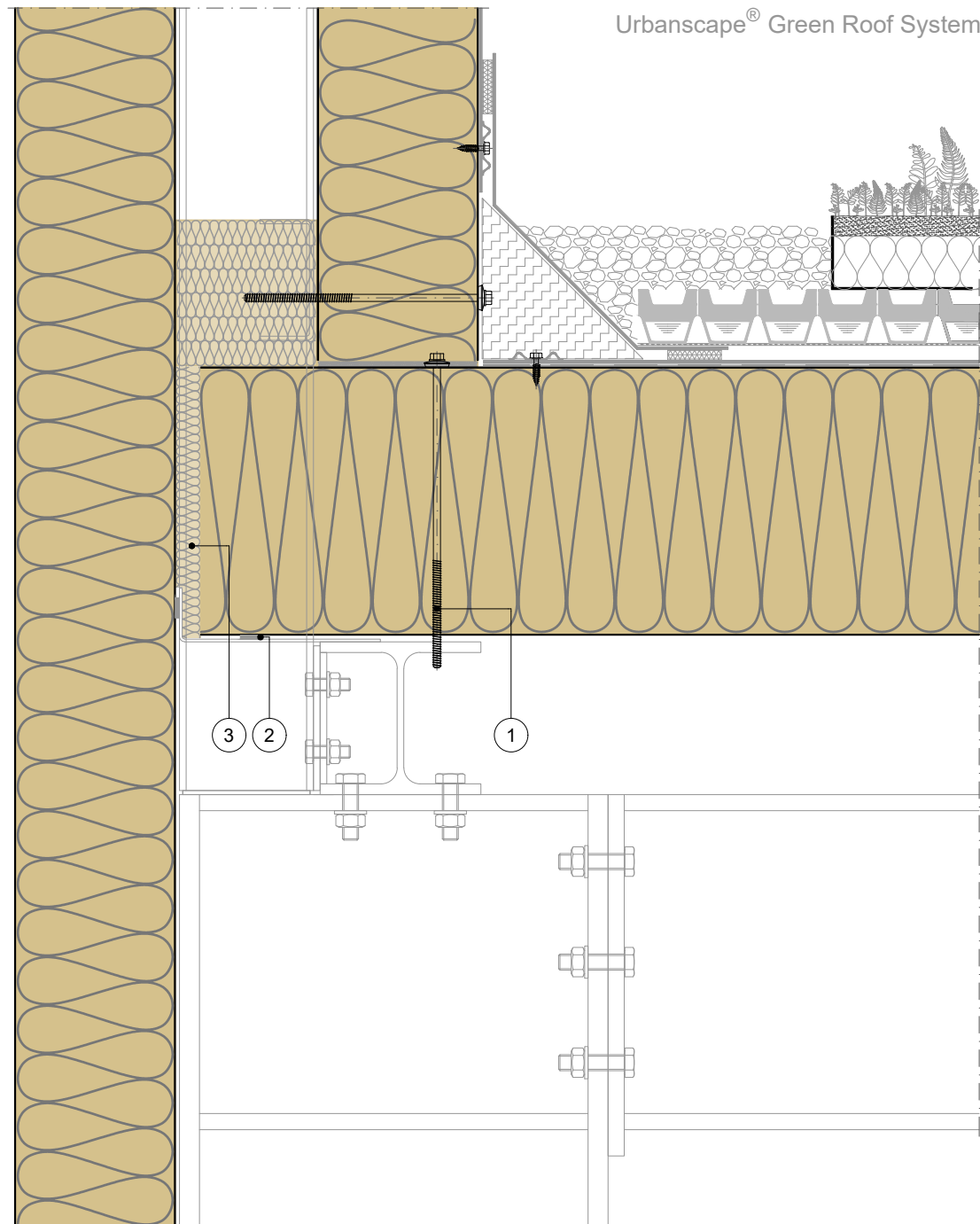

POS.	ELEMENT	SCALE: M 1:5
1	Fixing screw	
2	Sealing tape	
3	Thermal insulation	

PARAPET

Trimo Group holds full copyrights on the information and details provided on this media, therefore any unauthorized reproduction and distribution is strictly prohibited.



FLAT INSTALLATION

FUNCTION

- FIRE - fire-resistant system
- FOOGIENE - food & hygiene system
- BASE - backing-wall system

APPLICATION

- External Facade + External Soffit
- Internal Wall + Internal Ceiling
- Flat Roof Pitched Roof

TRIMOTERM FTV

DETAIL VIEW

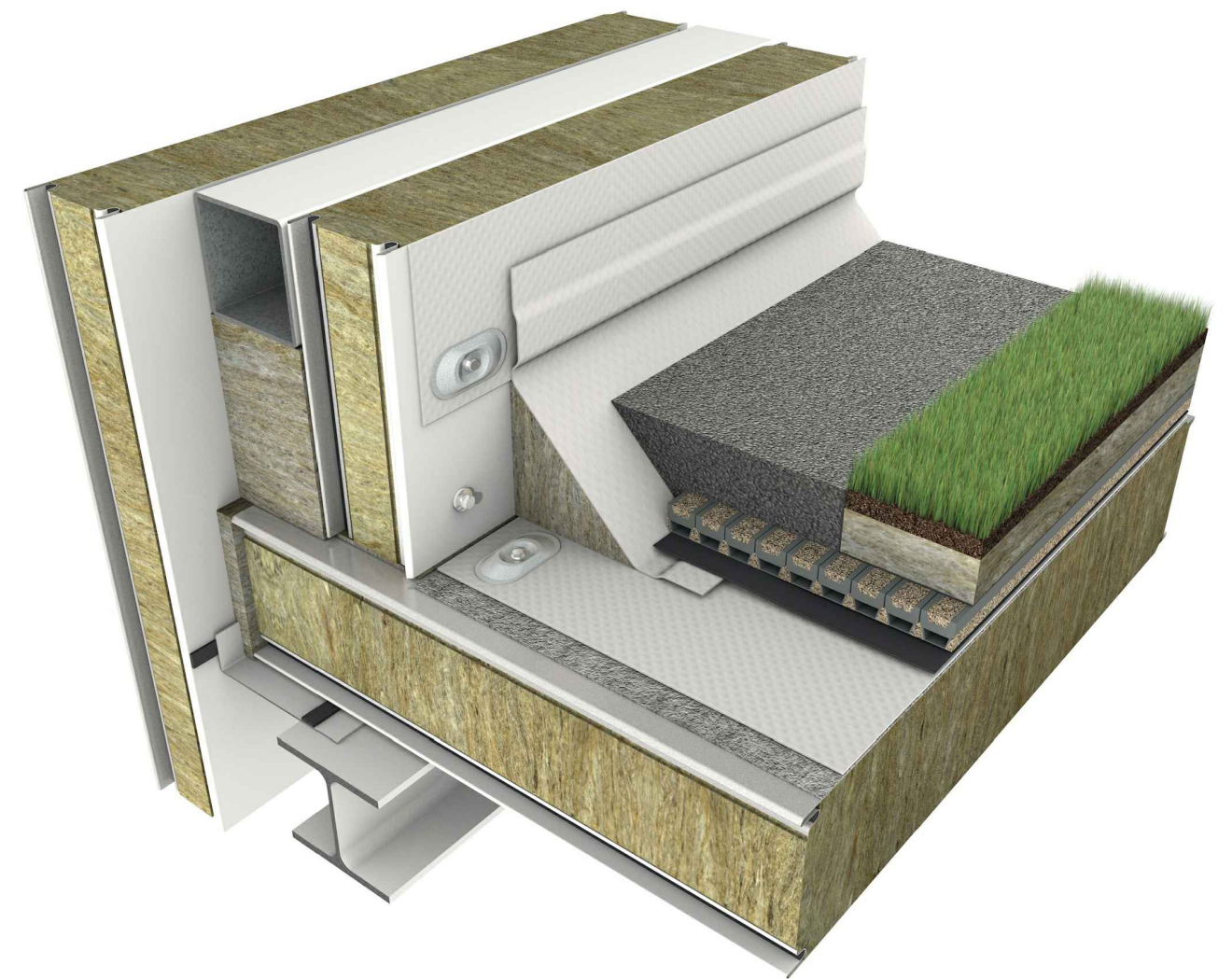

CLOSE VIEW

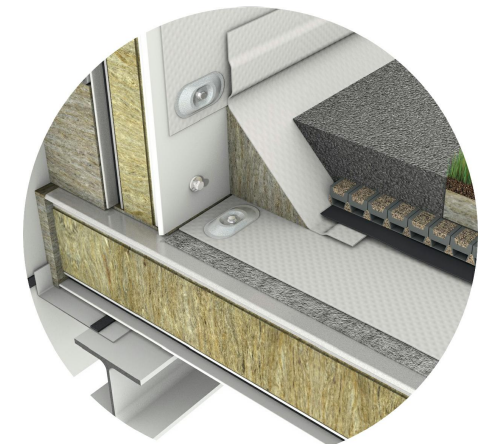

ADVANTAGES

- Prefabrication and load bearing
- Airtightness and internal side hygiene performance
- Compatibility and flexibility to other systems
- Sustainability and energy efficiency

PARAPET

Trimo Group holds full copyrights on the information and details provided on this media, therefore any unauthorized reproduction and distribution is strictly prohibited.



FLAT INSTALLATION

TRIMOTERM FTV

FUNCTION

- FIRE - fire-resistant system
- FOOGIENE - food & hygiene system
- BASE - backing-wall system

APPLICATION

- External Facade
- Internal Wall
- Flat Roof
- External Soffit
- Internal Ceiling
- Pitched Roof

VERTICAL CUT

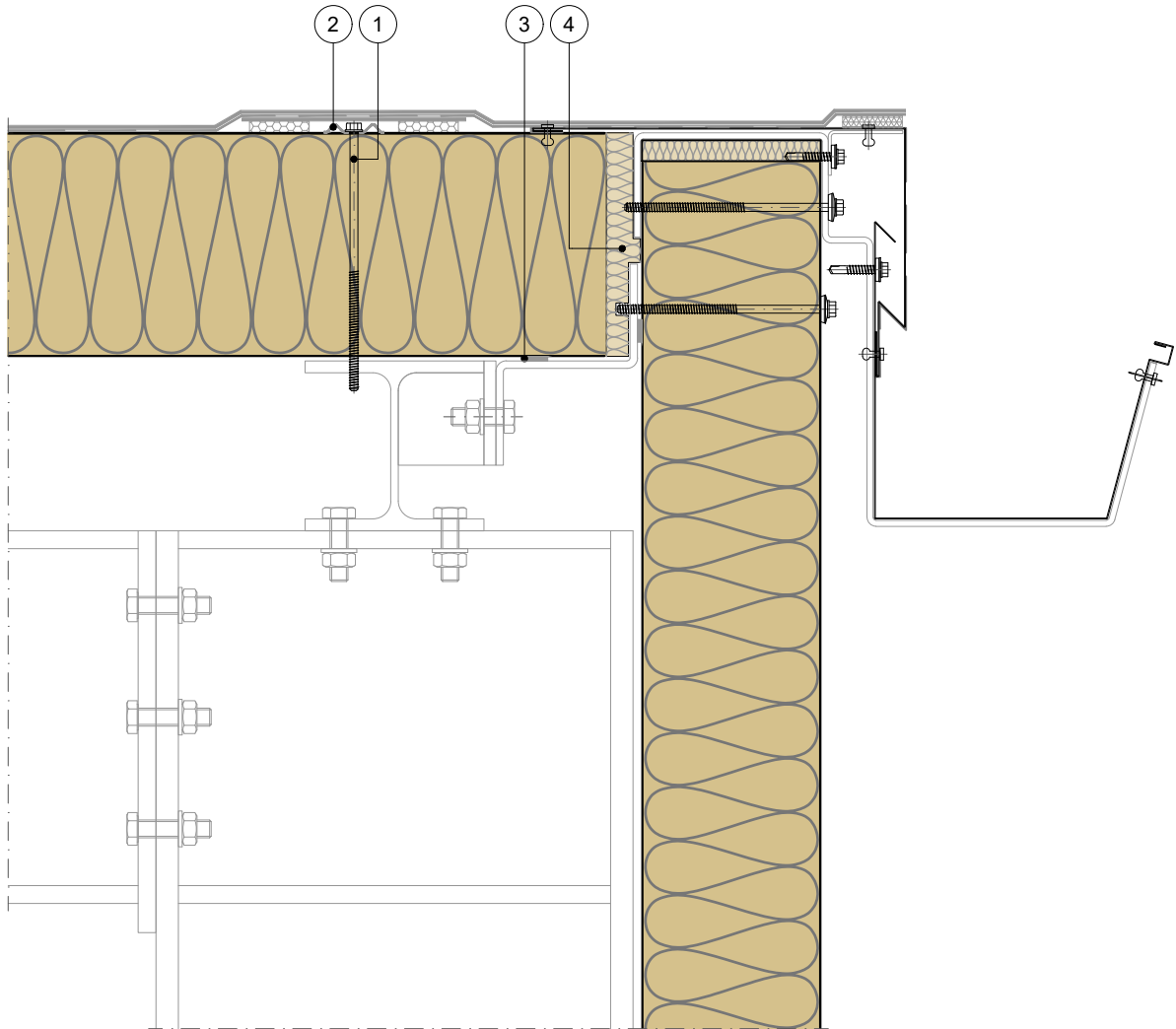

POS.	ELEMENT	SCALE: M 1:5
1	Fixing screw	
2	Stress plate	
3	Sealing tape	
4	Thermal insulation	

GABLE

Trimo Group holds full copyrights on the information and details provided on this media, therefore any unauthorized reproduction and distribution is strictly prohibited.



FLAT INSTALLATION

TRIMOTERM FTV

FUNCTION

- FIRE - fire-resistant system
- FOOGIENE - food & hygiene system
- BASE - backing-wall system

APPLICATION

- External Facade
- Internal Wall
- Flat Roof
- External Soffit
- Internal Ceiling
- Pitched Roof

VERTICAL CUT

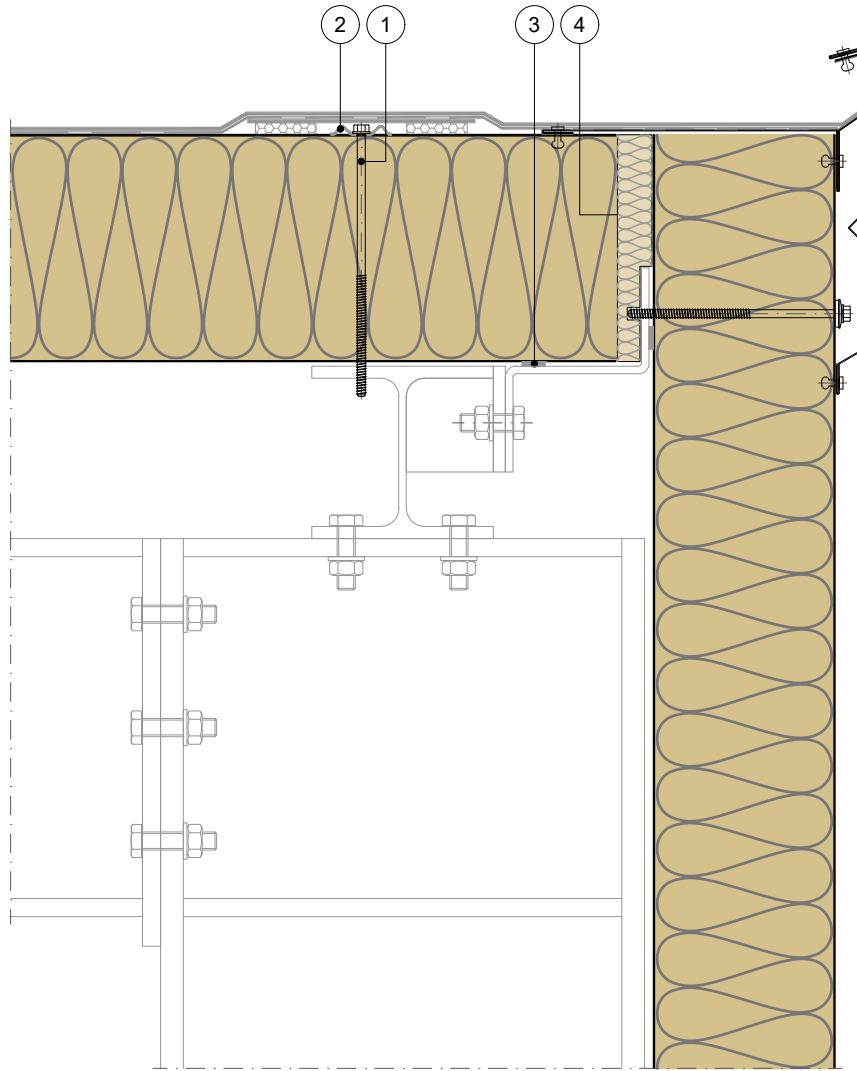

POS.	ELEMENT	SCALE: M 1:5
1	Fixing screw	
2	Stress plate	
3	Sealing tape	
4	Thermal insulation	

GABLE

Trimo Group holds full copyrights on the information and details provided on this media, therefore any unauthorized reproduction and distribution is strictly prohibited.



FLAT INSTALLATION

FUNCTION

- FIRE - fire-resistant system
- FOOGIENE - food & hygiene system
- BASE - backing-wall system

APPLICATION

- External Facade + External Soffit
- Internal Wall + Internal Ceiling
- Flat Roof
- Pitched Roof

TRIMOTERM FTV

VERTICAL CUT

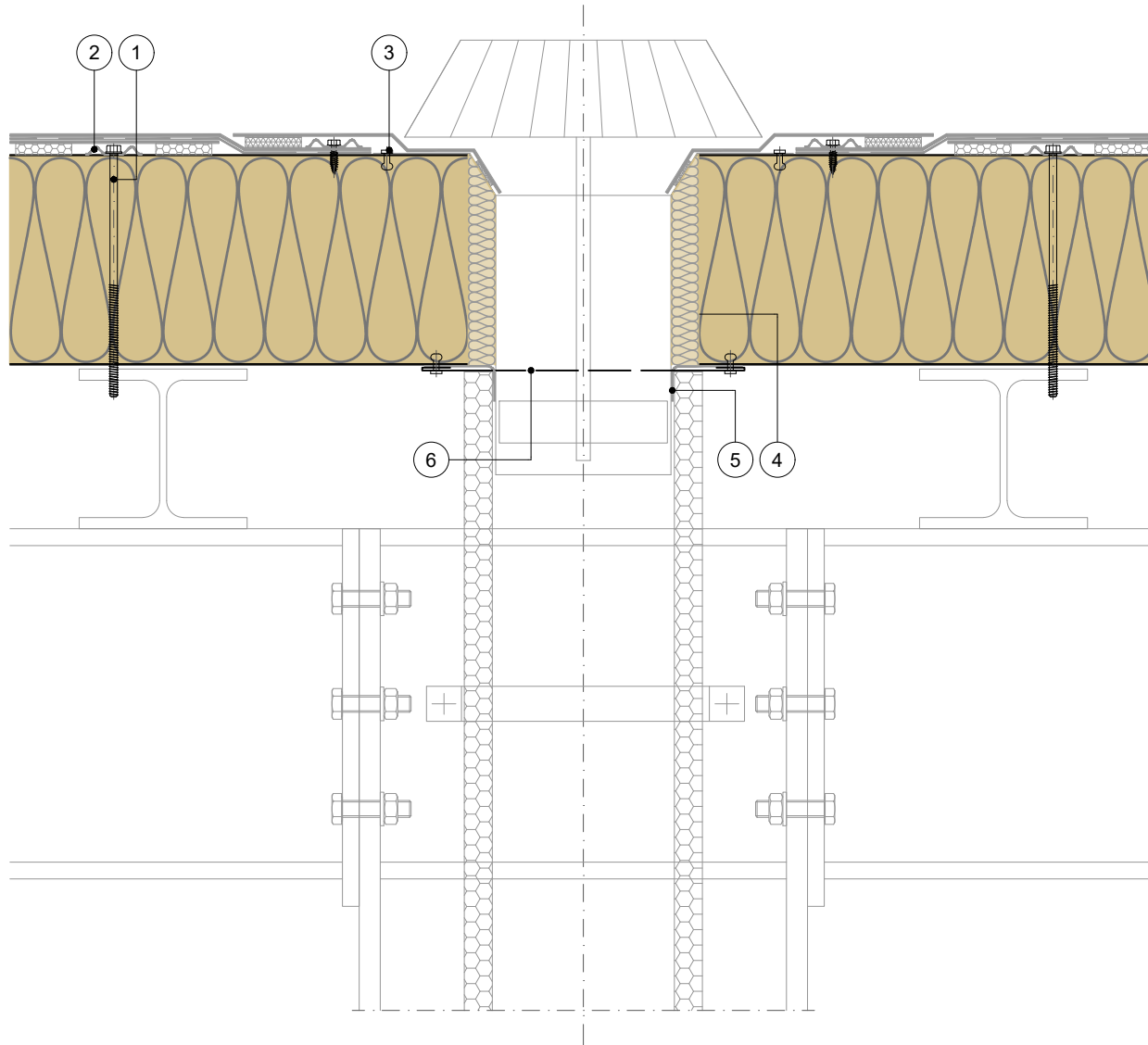

POS.	ELEMENT	SCALE: M 1:5
1	Fixing screw	
2	Stress plate	
3	Blind rivet	
4	Thermal insulation	
5	Vapour control layer	
6	Flashing	



FLAT INSTALLATION

FUNCTION

- FIRE - fire-resistant system
- FOOGIENE - food & hygiene system
- BASE - backing-wall system

APPLICATION

- External Facade + External Soffit
- Internal Wall + Internal Ceiling
- Flat Roof
- Pitched Roof

TRIMOTERM FTV

DETAIL VIEW

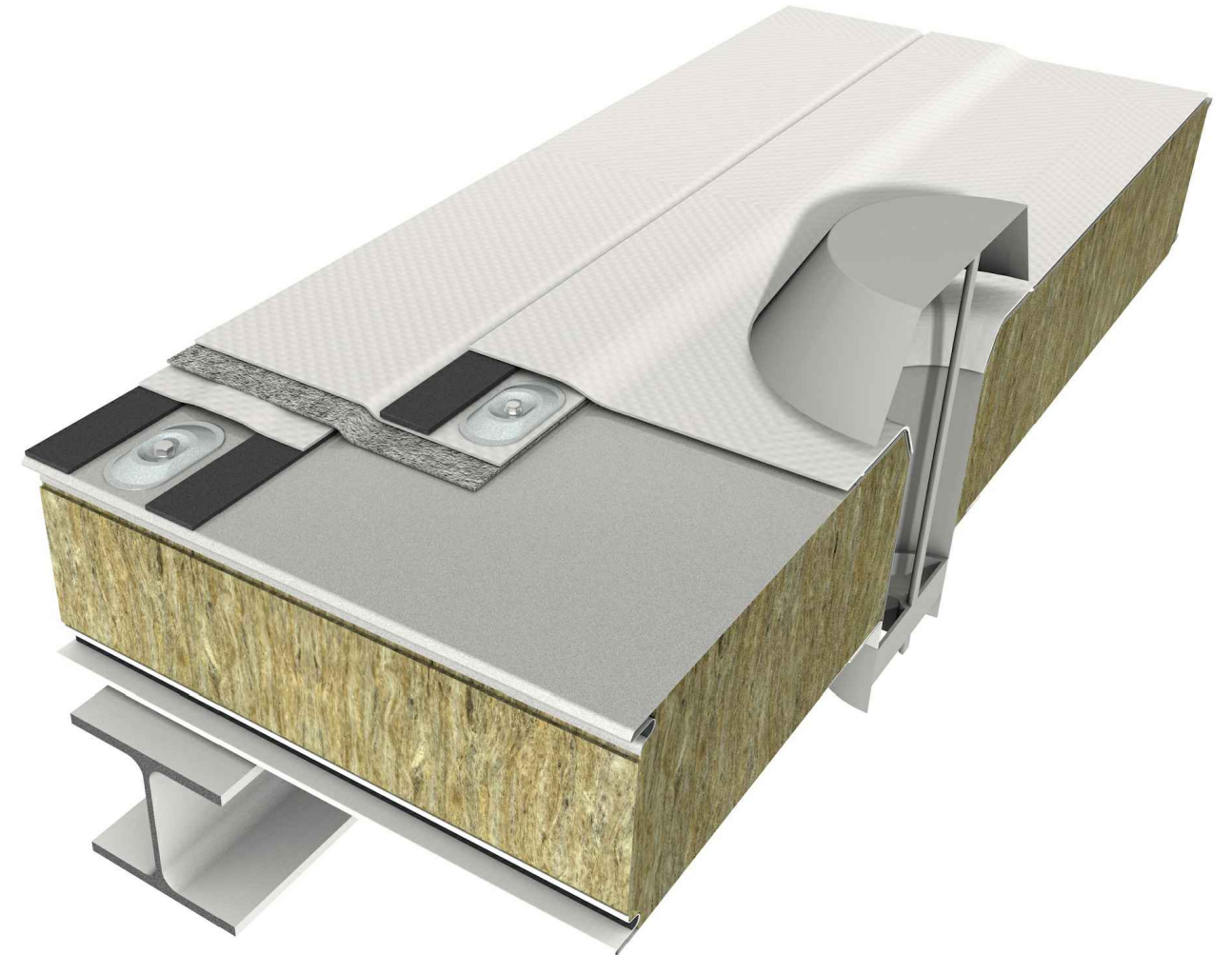

CLOSE VIEW



ADVANTAGES

- Prefabrication and load bearing
- Airtightness and internal side hygiene performance
- Compatibility and flexibility to other systems
- Sustainability and energy efficiency



FLAT INSTALLATION

FUNCTION

- FIRE - fire-resistant system
- FOOGIENE - food & hygiene system
- BASE - backing-wall system

APPLICATION

- External Facade + External Soffit
- Internal Wall + Internal Ceiling
- Flat Roof
- Pitched Roof

TRIMOTERM FTV

VERTICAL CUT

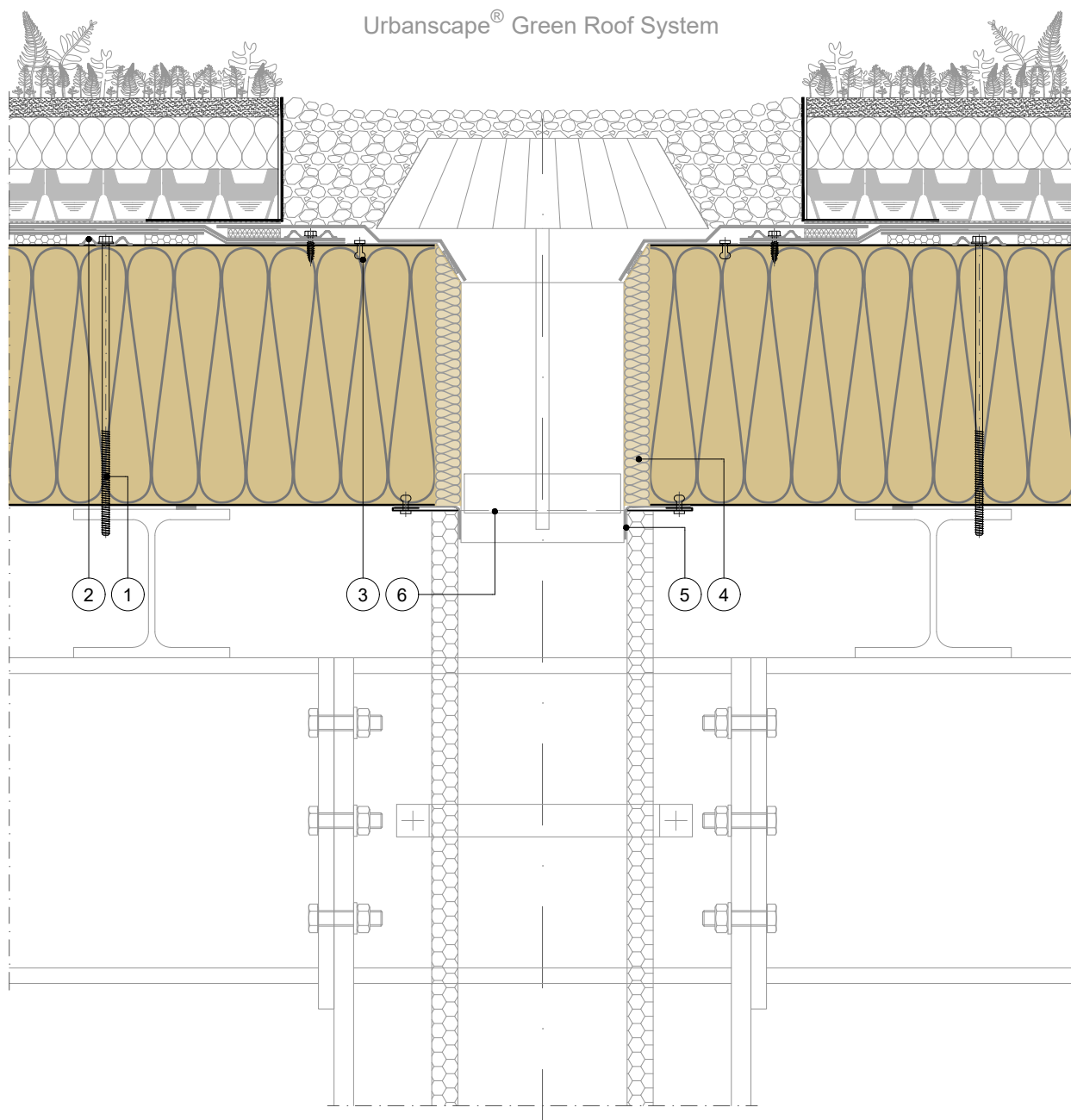

POS.	ELEMENT	SCALE: M 1:5
1	Fixing screw	
2	Stress plate	
3	Blind rivet	
4	Thermal insulation	
5	Vapour control layer	
6	Flashing	



FLAT INSTALLATION

FUNCTION

- FIRE - fire-resistant system
- FOOGIENE - food & hygiene system
- BASE - backing-wall system

APPLICATION

- External Facade + External Soffit
- Internal Wall + Internal Ceiling
- Flat Roof
- Pitched Roof

TRIMOTERM FTV

DETAIL VIEW

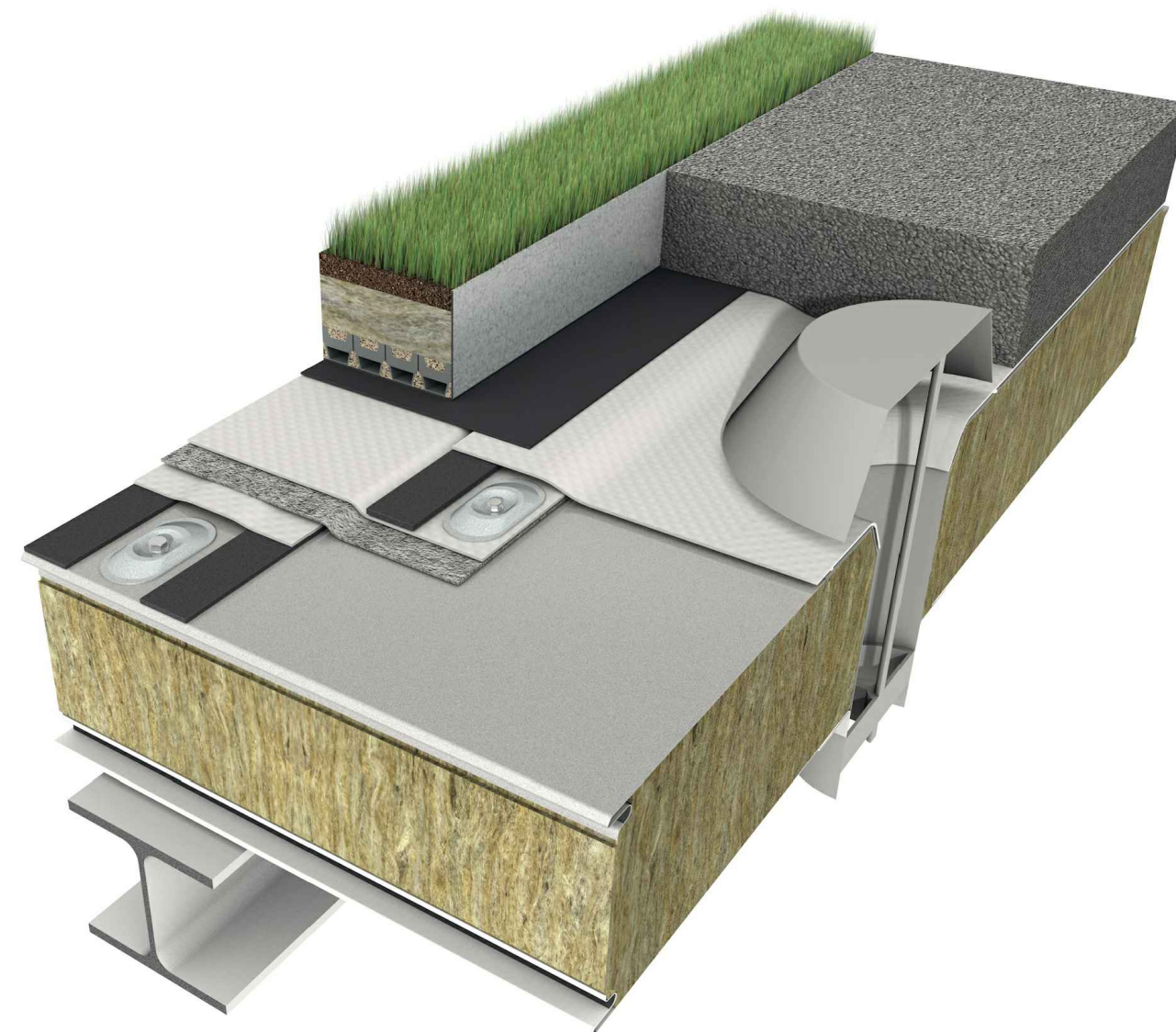

CLOSE VIEW

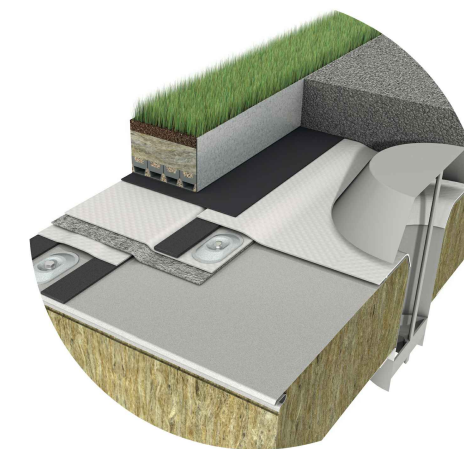

ADVANTAGES

- Prefabrication and load bearing
- Airtightness and internal side hygiene performance
- Compatibility and flexibility to other systems
- Sustainability and energy efficiency



FLAT INSTALLATION

TRIMOTERM FTV

FUNCTION

- FIRE - fire-resistant system
- FOOGIENE - food & hygiene system
- BASE - backing-wall system

APPLICATION

- External Facade
- Internal Wall
- Flat Roof
- External Soffit
- Internal Ceiling
- Pitched Roof

VERTICAL CUT

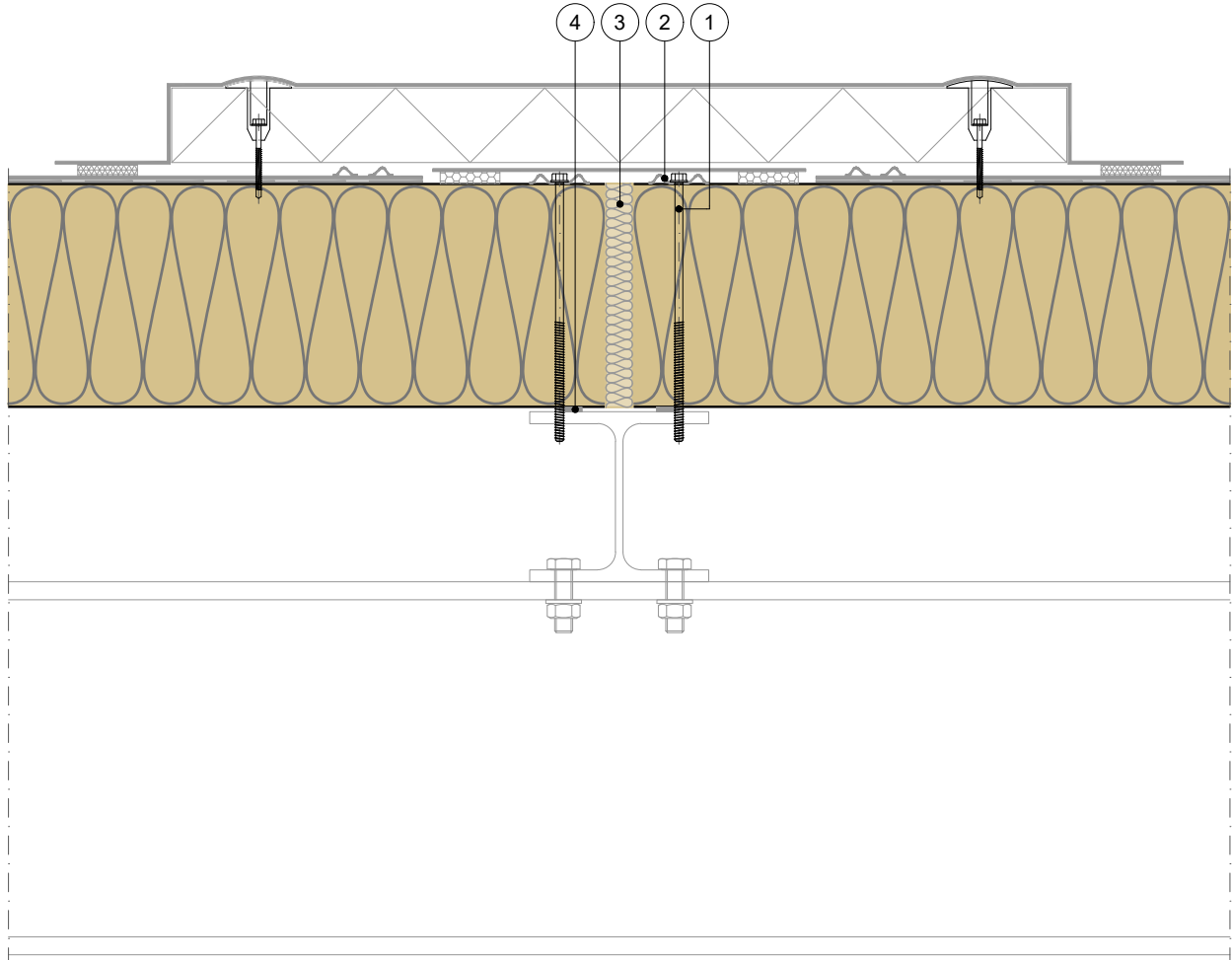

POS.	ELEMENT	SCALE: M 1:5
1	Fixing screw	
2	Stress plate	
3	Thermal insulation	
4	Sealing tape	

ADDITION

Trimo Group holds full copyrights on the information and details provided on this media, therefore any unauthorized reproduction and distribution is strictly prohibited.



FLAT INSTALLATION

TRIMOTERM FTV

FUNCTION

- FIRE - fire-resistant system
- FOOGIENE - food & hygiene system
- BASE - backing-wall system

APPLICATION

- External Facade
- Internal Wall
- Flat Roof
- External Soffit
- Internal Ceiling
- Pitched Roof

VERTICAL CUT

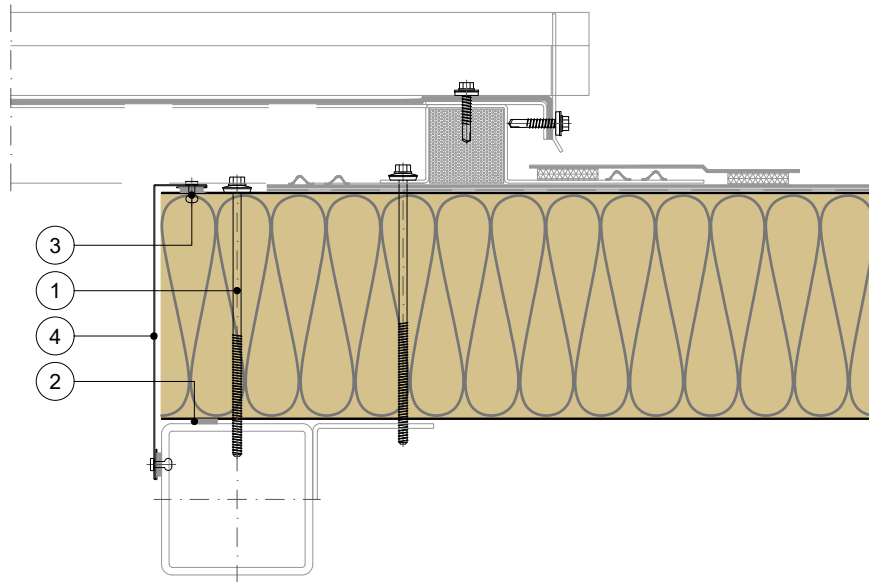
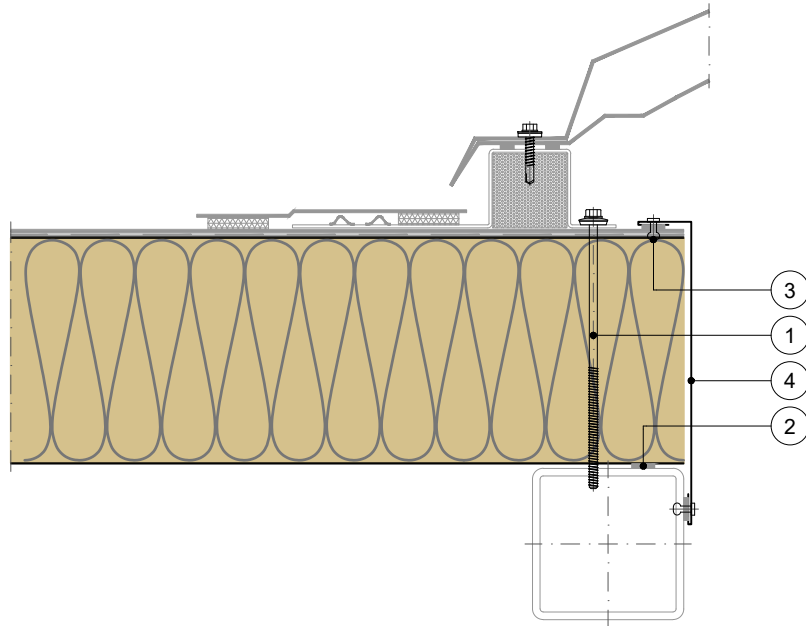

POS.	ELEMENT	SCALE: M 1:5
1	Fixing screw	
2	Sealing tape	
3	Blind rivet	
4	Flashing	

PENETRATION

Trimo Group holds full copyrights on the information and details provided on this media, therefore any unauthorized reproduction and distribution is strictly prohibited.